

You
don't
need to
pay a lot of
money for
high quality.

Classic Pergola with Innovative Touch

Classic Pergola.

Retractable fabric roof system producing by SUNSET

www.sunsetpergola.com.tr

Main differences of our Classic Pergola

Content List



TYPES

12 type designed
pergola models



PROFILES

3 system frame
types



PARTS

High quality
parts



WATER

Special solutions against
water leakage and evacuation.

Main differences of our Classic Pergola

Content List



LIGHTING

Single & multi
lighting system



INSTALLATION

Easy installation
method



DOCUMENTATION

Documentatiin
Library



SUPPORT

Customer
Support

Other companies offer you little variety of products.



Explain

If you want to buy a classic pergola from other companies, they will offer you fewer types of system design.



Classic Pergola

Multiple choice

From our companies catalog, you can choose most ergonomic pergola design that will be suitable for your location.



Advantage?

Wall mounted,
Free Standing,
Parasol design
types.

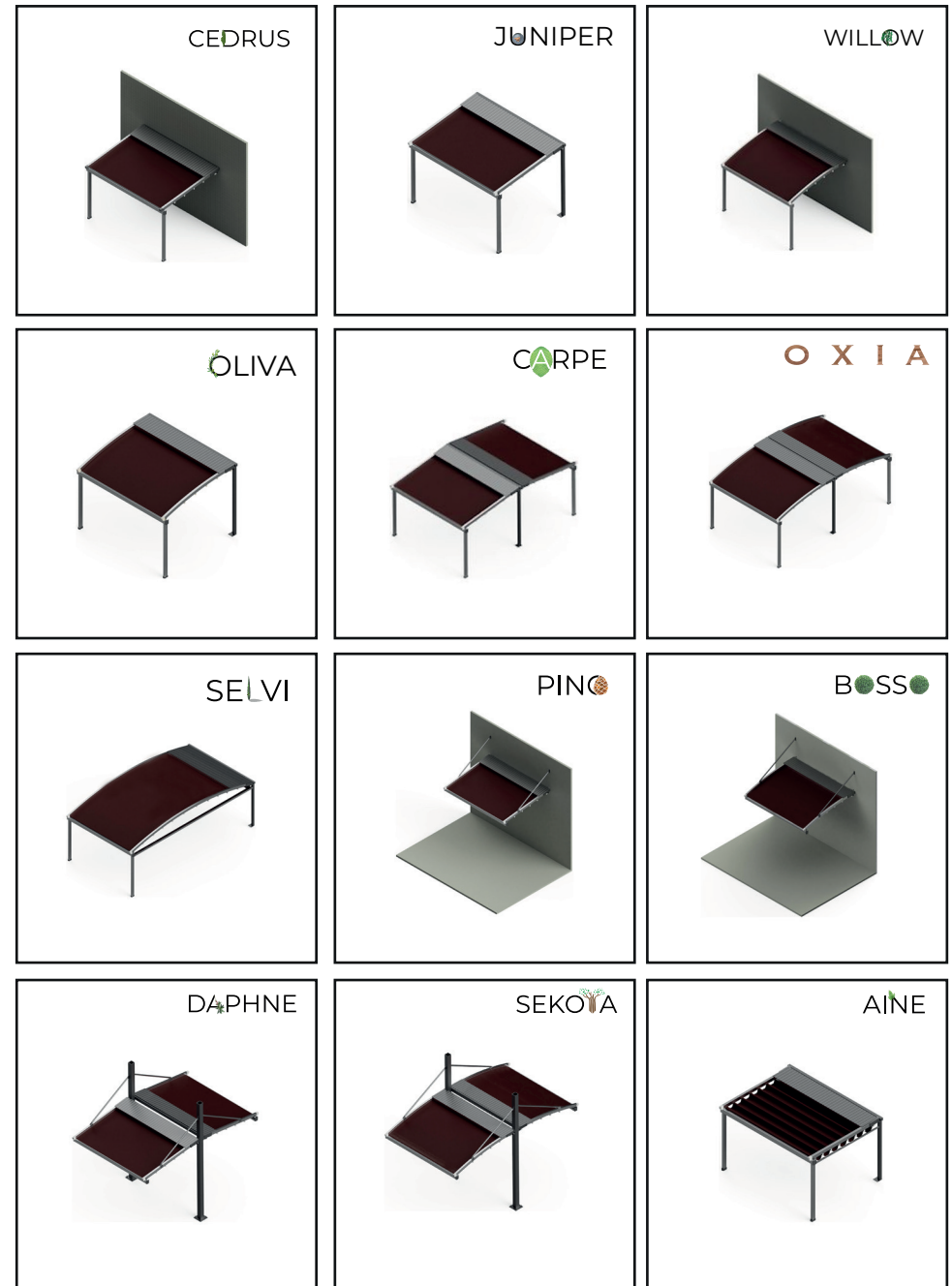

Weak System Profiles

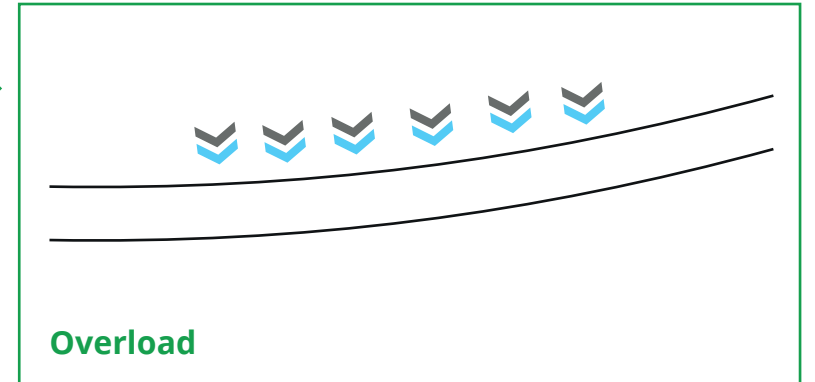

Explain

In case of insufficient profile section designs, bending may occur in large projects.

Classic Pergola

High load capacity

In large projections, Sunset replaces the carrier profiles and offers the customer a product with a higher load capacity.

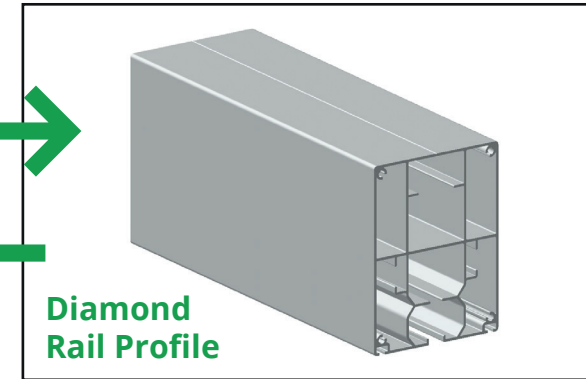
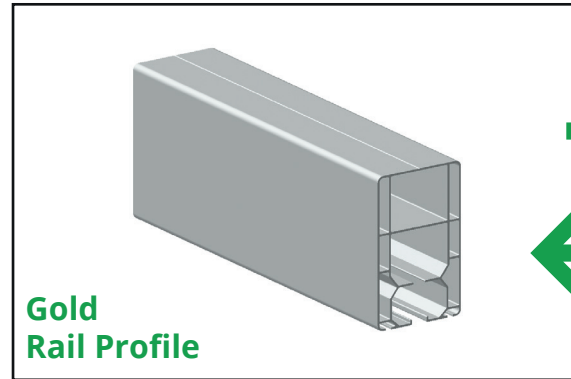
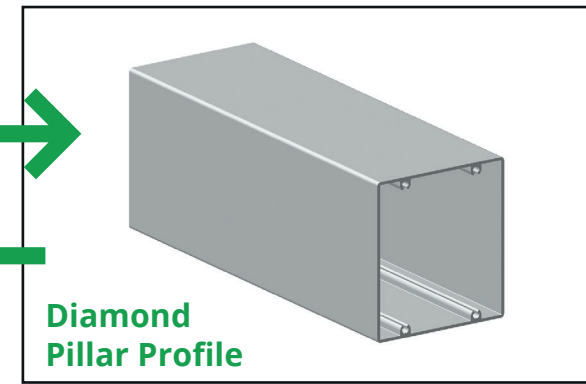
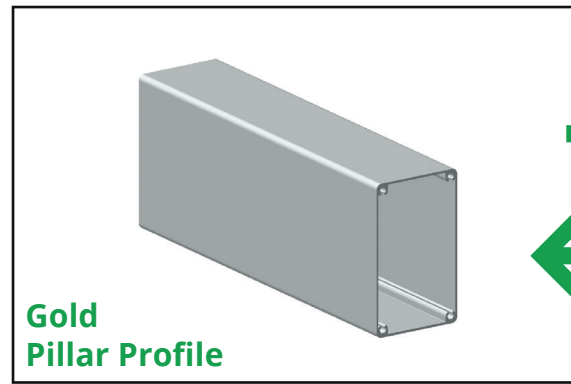
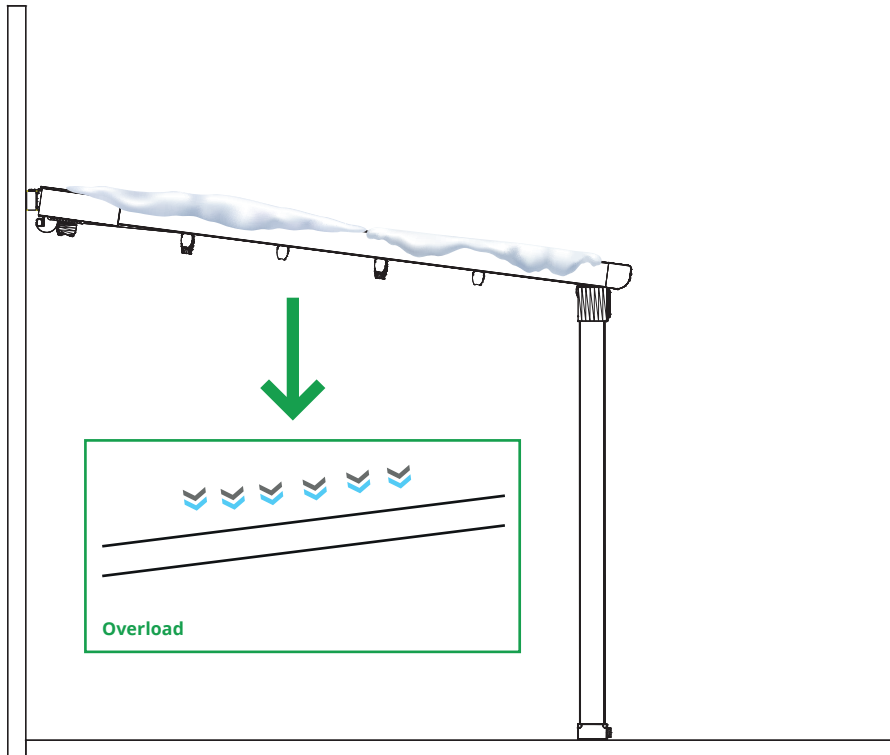

Advantage?

Not affected by high snow and other loads.

High Quality Components



Cheap Components

Other companies design and sell products using standard inexpensive parts. These products, which are very low in quality, lose their working form in a short time.



Every part of the product is from the best in the world

Powder Coat

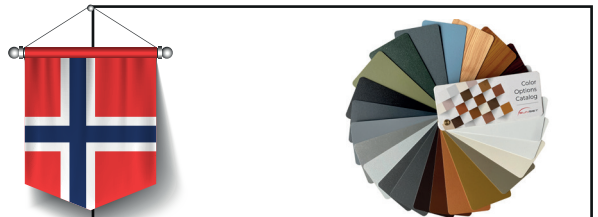

NORWAY **JOTUN**

Aluminum

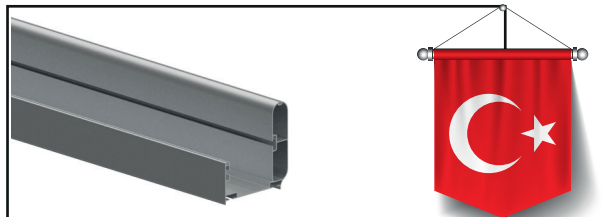

TURKEY (DIN 6060 / DIN 6061)

Roof Fabric



BELGIUM **SIOEN**

Motor

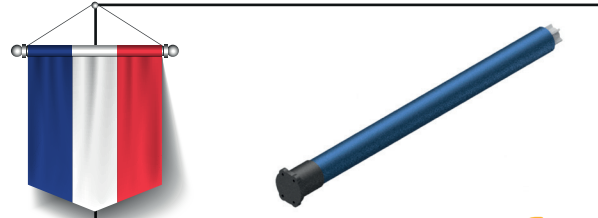

FRANCE **somfy**

Lighting

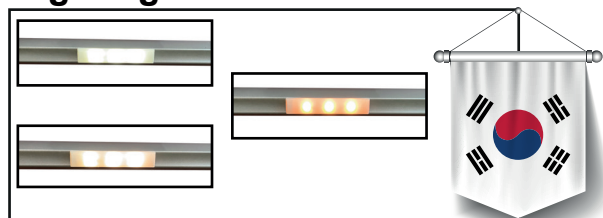

SOUTH KOREA **SAMSUNG**

Electricity Parts

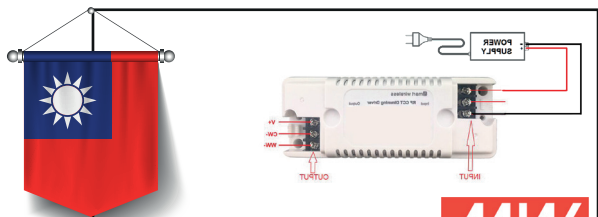

TAIWAN **MW MEAN WELL**

System Belt

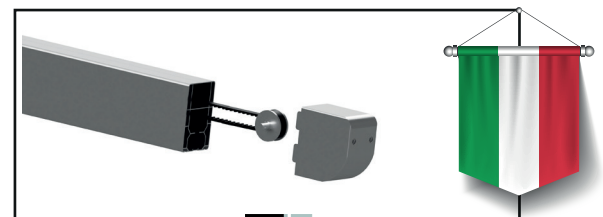

ITALY **Elatech®**
Tech Technology in Motion.



**Umbrella
under the
Pergola?**

**Of course
funny...**



Next Generation Water Draining

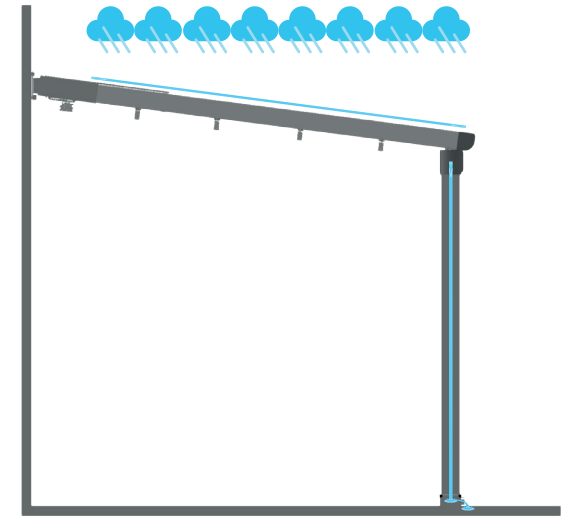
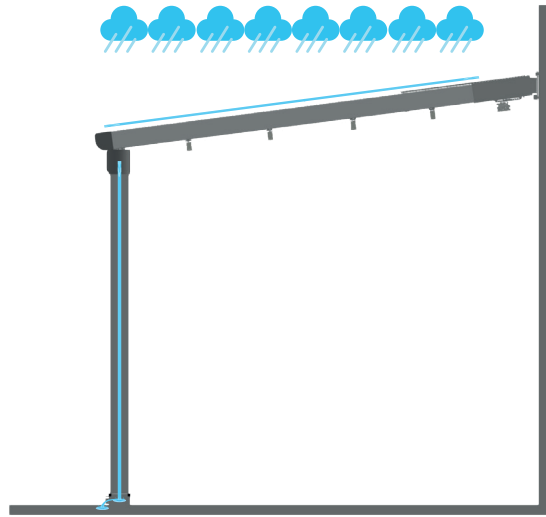

Side View

Side View

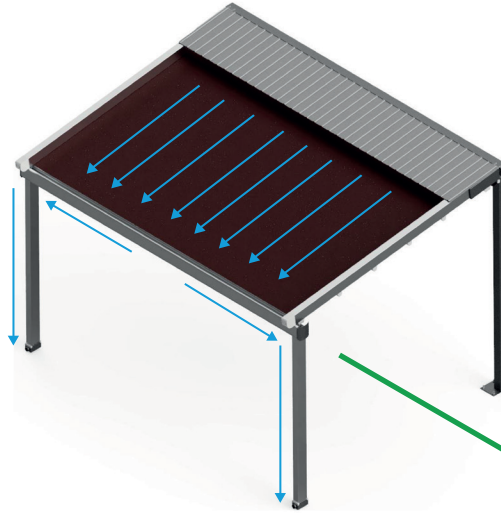
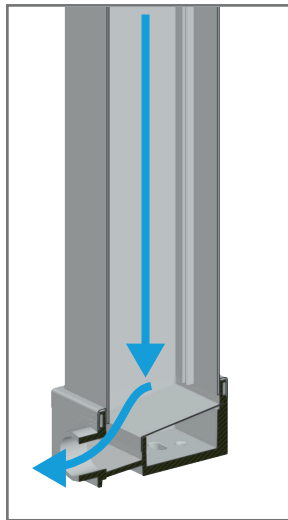
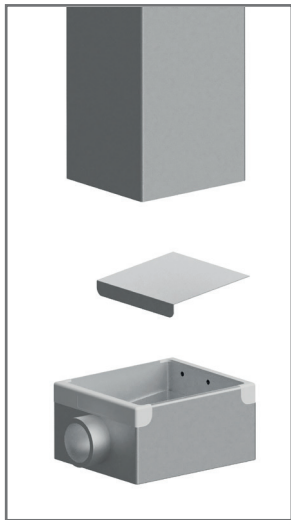

For the first time in the Pergola sector, the "Discharge Evacuation" solution is exclusive to Sunset.

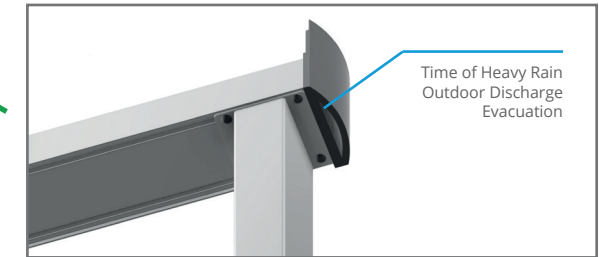
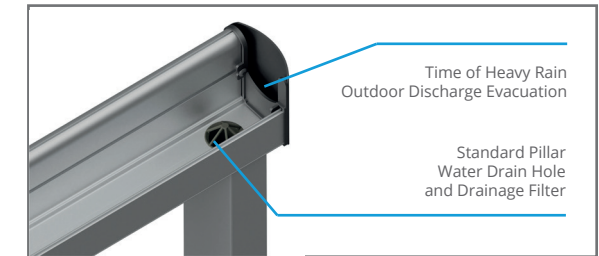

**Perfect
Lighting...**

**Better
than
temporary
stars**



Multi-Type Lighting System

In our products, we offer our customers
3 types of lighting options suitable
for every ambience.

Cool White



Day Light



Amber



Did you know that Pergola can only be installed in 5 steps.



**For 6x4 m
example
product,
total
installation
time
approximately
8 hours.**



**There are
always will
be broken
promises.**

**Ask for the
documents...**



Welcome to the SUNSET library

For every SUNSET PERGOLA product, we can present, presentation catalogs, qualification certificates (for each part & general system), technical datasheet, static reports, and installation guides. Day by day we improve our documental database. Sunset is one of the biggest companies, their professional team behind our documental development.

Catalogs



Certificates

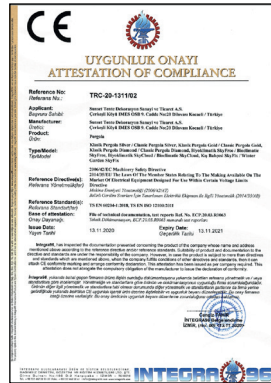

Technical Datasheet



Static Reports

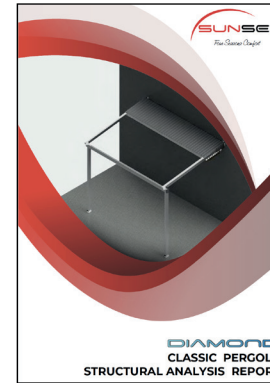

Installation Guides

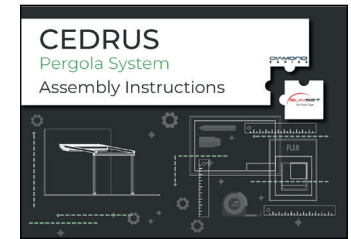

We offer digital versions of our documents.

We offer print versions of our documents.

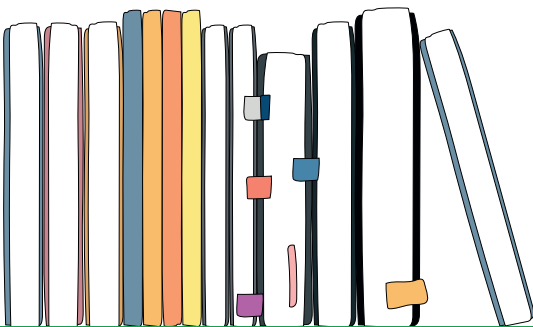
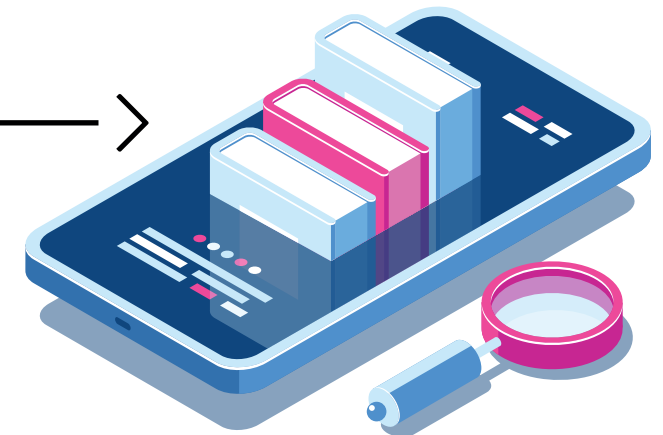

**Sometimes
after
purchase
you can't
find
anyone...**



**We
Are
Happy
Family**

For every SUNSET PERGOLA product installation process we are giving full of our support with technicians videocall & installation documents.

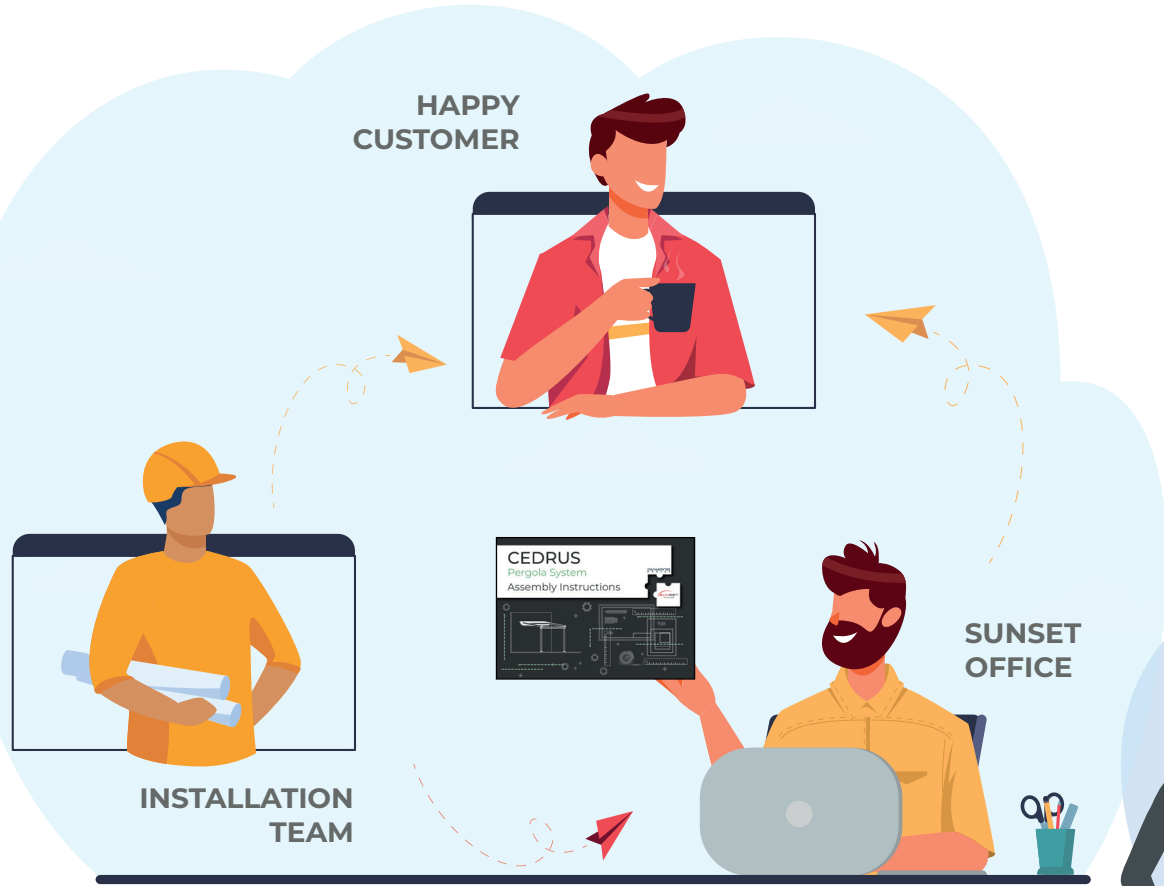

+5000 successfully projects we are big family with our happy customer portfolio. Hope you join our family as soon as possible.

support@sunsetpergola.com.tr
sales@sunsetpergola.com.tr



CLASSIC PERGOLA

